

K Series

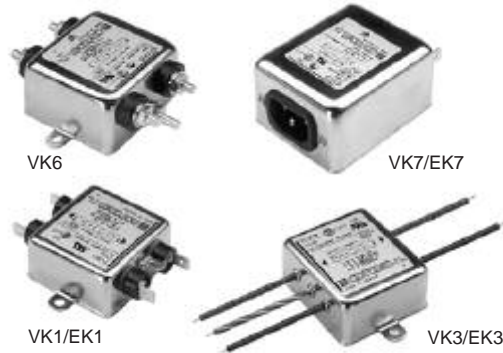

UL Recognized
CSA Certified
VDE Approved



K Series

The K series RFI power line filters are general purpose common-mode and differential-mode filters. They are effective in the control of line-to-line as well as line-to-ground RFI interference. The K series RFI filters are particularly suited in applications where pulsed, continuous and/or intermittent RFI interference is present. The EK models meet the very low leakage current requirements of VDE portable equipment, and (120 Volt) UL544 non-patient medical equipment.

Electrical Schematics

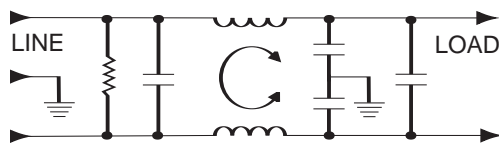

30VK6C Model (Inductor in Ground Line)

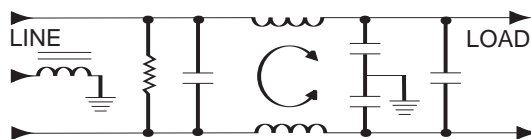

60VK6 Model

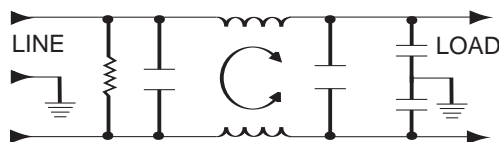

Resistor location for reference only.

Specifications

Maximum leakage current, each line-to-ground

	<u>VK Models</u>	<u>EK Models</u>
@ 120 VAC 60 Hz:	.5 mA	.21 mA
@ 250 VAC 50 Hz:	1.0 mA	.36 mA

Hipot rating (one minute):

line-to-ground	2250 VDC
line-to-line	1450 VDC

Operating frequency:

50/60 Hz

Rated voltage (max.):

250 VAC

Minimum insertion loss in dB:

Line-to-ground in 50 ohm circuit

Current Rating	Frequency-MHz					
	.15	.5	1	5	10	30
VK Models						
1A, 3A	15	30	38	50	50	50
2A, 5A, 10A	6	19	28	42	45	50
20A, 30A, 40A	6	19	28	42	45	50
60A	6	22	28	32	39	35
EK Models						
1A, 3A	15	29	35	45	45	50
2A, 5A, 10A, 20A	8	19	25	38	40	45

Line-to-line in 50 ohm circuit

Current Rating	Frequency-MHz					
	.15	.5	1	5	10	30
VK, EK Models						
1A, 3A	-	-	48	55	50	35
2A, 5A, 10A	-	-	30	50	30	30
20A	6	6	30	50	30	30
VK Models						
30A, 40A	2	40	60	65	57	55
60A	13	49	67	57	53	53
EK Models						
30A	6	6	30	50	30	30

K Series

Case Styles

K1

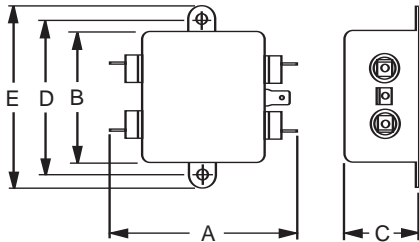

Typical dimensions:
 Terminals: .250 [6.35] (5) Holes: .07 [1.8] Dia. (4)
 Slot: .07 x .16 [1.8 x 4.1] Mounting holes: .188 [4.78] Dia. (2)

K3

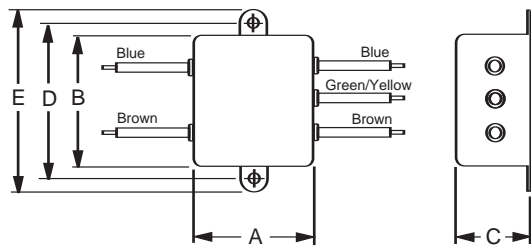

Typical dimensions:
 Wire leads: 4.0 [101.6] Min. Mounting holes: .188 [4.78] Dia. (2)

20EK1/20VK1

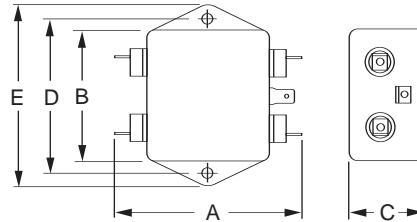

10VK6

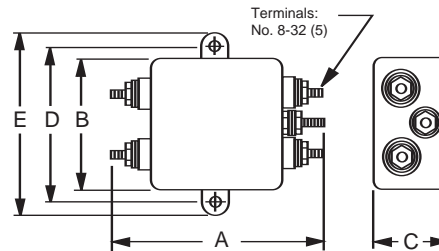

Typical dimensions:
 Mounting holes: .188 [4.78] Dia. (2) Torque 18±2 in.lb

K Series

Case Styles

20VK6

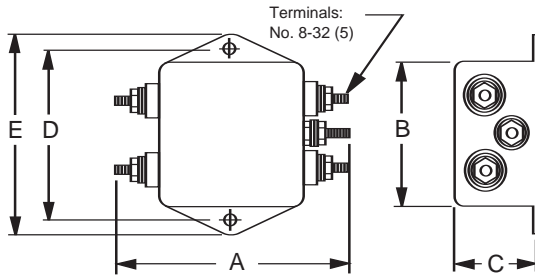

30VK6 & 30VK6C, 40VK6 & 40VK6C

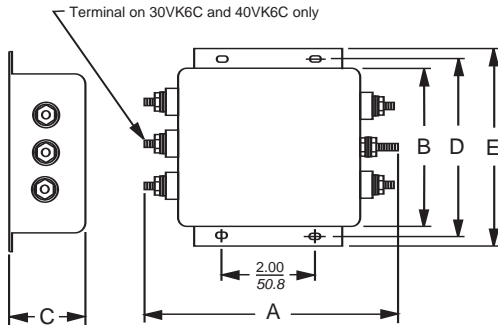

Typical dimensions:
 Terminals: No. 8-32 (5) Torque: 18 ± 2 in. lb.
 Slots: .250 [6.35] x .156 [3.96] (4) Mounting holes: .188 [4.78] Dia. (2)

60VK6

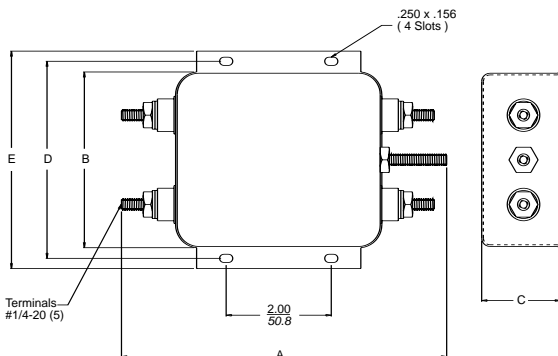

K7 & K7M

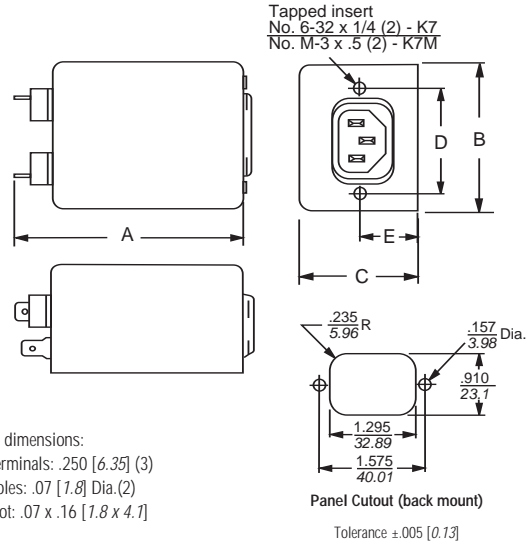

20VK7 (with metric insert)

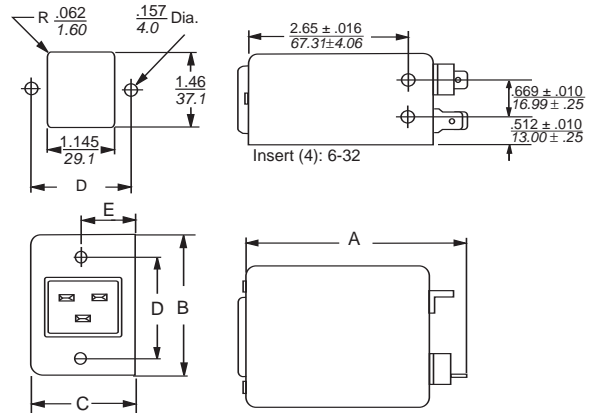

K Series

Case Styles

Case Dimensions

Part No.	A (max)	B (max)	C (max)	D $\frac{\pm .015}{\pm .38}$	E (max)
1VK1, 1EK1,	3.1	2.07	0.91	2.375	2.81
2VK1, 2EK1	78.7	52.6	23.1	60.33	71.4
1VK3, 1EK3,	1.81	2.07	0.91	2.375	2.81
2VK3, 2EK3	46.0	52.6	23.1	60.33	71.4
3VK1, 3EK1,	3.10	2.07	1.16	2.375	2.81
5VK1, 5EK1	78.7	52.6	29.5	60.33	71.4
3VK3, 3EK3,	1.81	2.07	1.16	2.375	2.81
5VK3, 5EK3	46.0	52.6	29.5	60.33	71.4
3VK7, 3VK7M,	3.21	2.25	1.28	1.575	0.63 †
3EK7, 3EK7M	81.5	57.2	32.5	40.01	16.0 †
5VK7, 5VK7M,	3.21	2.25	1.28	1.575	0.63 †
5EK7, 5EK7M	81.5	57.2	32.5	40.01	16.0 †
10VK1,	3.35	2.07	1.16	2.375	2.81
10EK1	85.1	52.6	29.5	60.33	71.4
10VK3,	2.07	2.07	1.16	2.375	2.81
10EK3	52.6	52.6	29.5	60.33	71.4
10VK6	3.46	2.07	1.16	2.375	2.81
	87.9	52.6	29.5	60.33	71.4
10VK7, 10VK7M,	3.71	2.25	1.28	1.575	0.63 †
10EK7, 10EK7M	94.2	57.2	32.5	40.01	16.0 †
20VK1,	3.35	2.56	1.53	2.938	3.35
20EK1	85.1	65.0	38.9	74.63	85.1
20VK6	3.46	2.56	1.53	2.938	3.35
	87.9	65.0	38.9	74.63	85.1
20VK7	3.8	2.28	1.78	1.575	.846 †
	90.4	54.6	39.6	74.63	85.8 †
30VK6,	5.34	3.38	1.53	3.75	4.20
30VK6C	135.6	85.9	38.9	95.25	106.7
40VK6,	5.34	3.38	1.53	3.75	4.20
40VK6C	135.6	85.9	38.9	95.25	106.7
60VK6	6.189	3.344	1.50	3.75	4.136
	157.2	84.94	38.1	95.25	105.05

† ±.02 [±0.5]

‡ ±.01 [±.025]



RFI Power Line Filters

Part Numbers

1VK1	1EK1
1VK3	1EK3
2VK1	2EK1
2VK3	2EK3
3VK1	3EK1
3VK3	3EK3
3VK7	3EK7
3VK7M	3EK7M
5VK1	5EK1
5VK3	5EK3
5VK7	5EK7M
5VK7M	10EK1
10VK1	10EK3
10VK3	10EK7
10VK6	10EK7M
10VK7	20EK1
10VK7M	
20VK1	
20VK6	
20VK7	
30VK6	
30VK6C	
40VK6	
40VK6C	
60VK6	

Line Cord No. GA400